



# CORI-FLOW™

Coriolis Mass Flow Meters / Controllers  
for Liquids and Gases



## › Introduction

Bronkhorst® manufactures precise, compact Mass Flow Meters and Controllers for gases and liquids, based on the Coriolis measuring principle. The instruments are made to customers' specification, suitable for use in laboratory, for integration in manufacturing machines and pilot plants and even for application in industrial or hazardous areas.

## › CORI-FLOW™ series direct mass flow meters and controllers

Bronkhorst®, specialists in low flow measurement and control, designed the CORI-FLOW™ series mass flow metering instruments to provide high accuracy in two classes:  $\pm 0,2\%$  or  $\pm 0,5\%$  of Reading.

CORI-FLOW™ utilises an advanced Coriolis type mass flow sensor to achieve unsurpassed performance even with changing operating conditions in pressure, temperature, density, conductivity and viscosity. The instruments are offered as separate flow meters or with close-coupled control valve or pump, thus constituting a compact Coriolis-type mass flow controller. The instruments have analog (0-5 Vdc / 4-20 mA) and RS232 output as standard and can, as options, be equipped with interface to PROFIBUS DP, DeviceNet™, Modbus-RTU or FLOW-BUS.

There are 2 models with overlapping nominal flow ranges from 200 g/h up to 600 kg/h (full scale value), each offering "multi-range" functionality: factory calibrated ranges can be rescaled by the user, maintaining the original accuracy specs. Both meters and controllers are equipped with an IP65 weatherproof housing and are available with ATEX approval for use in Zone 2 hazardous areas.

## › Fields of application

CORI-FLOW™ instruments are applied in process fluid measurement or control systems in food, (petro-) chemical and pharmaceutical industries, in fermentation installations, in semiconductor processing and in fuel cell technology. Some typical examples of applications are described further on in this brochure.

## › General CORI-FLOW™ features

- ◆ Direct mass flow measurement
- ◆ Independent of fluid properties
- ◆ Integrated PID controller for control valve or pump
- ◆ Fast response time
- ◆ High accuracy, excellent repeatability
- ◆ Compact, IP65 housing
- ◆ Optional: ATEX approval Cat.3, Zone 2
- ◆ Option: bidirectional measurement

## › Digital features

- ◆ Standard: RS232
- ◆ Options: PROFIBUS DP, DeviceNet™, Modbus RTU or FLOW-BUS
- ◆ Other fieldbus options on request
- ◆ Alarm and (batch) counter functions



# CORI-FLOW™ for Liquids and Gases

## › Measuring principle

The CORI-FLOW™ contains two parallel tube loops, forming part of an oscillating system. When a fluid flows through the tubes, Coriolis forces cause a variable phase shift between the loops, which is detected by sensors and fed into the integrally mounted pc-board. The resulting output signal is strictly proportional to the real mass flow rate.

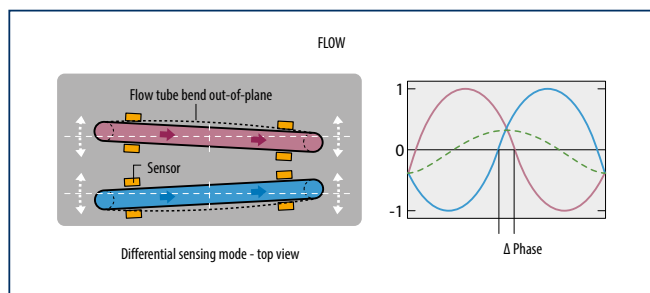
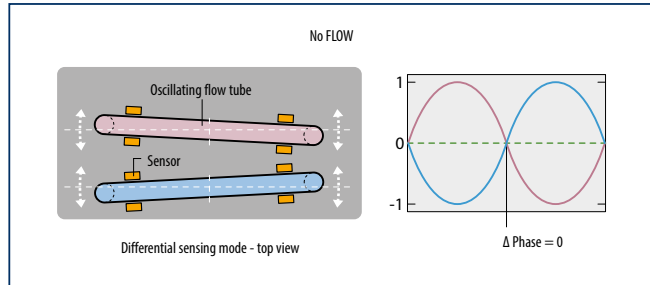

## › Technical specifications

### Performance flow sensor

Accuracy	Liquid	0,2% of rate, range 1...100%
	Gas	0,5% of rate, range 1...100%

### Flow sensor rates (values in kg/h)

	M54	M55
Max. flow FS rate	100	600
Min. flow FS rate Liquid	5	20
Min. flow FS rate Gas	10	50
Recommended min. flow	0,2	0,5
Zero stability	< 0,050	< 0,100
Repeatability	0,1% of rate (based on digital output)	
Mounting position	preferred mounting position on liquid service upside down	

### Operating limits flow controller

Control range	2...100% (with elastomeric seat)
Auto shut off	valve closes when setpoint drops below 1,6%
Liquids and Gases	any clean, homogeneous liquid or gas compatible with AISI 316 (or Hastelloy-C22 as an option)
Differential pressure mass flow controller	recommended $\Delta P$ across control valve at least 50% of total $\Delta P$ for liquids and gases.
Settling time	approx. 0,5 s

### Mechanical

Process connections	std. 1/4" face seal male, 1/4" or 6 mm OD compression type; other on request
Material of construction (wetted parts)	stainless steel AISI 316L or equivalent; option for M54: Hastelloy-C22
Weight	meter approx. 3,1 kg meter + integral valve 4,4 kg (max.)
Ingress protection	IP 65 (weatherproof) for meter; for controller on request
Leak integrity	< $2 \times 10^{-9}$ mbar l.s <sup>-1</sup> He
Pressure test	1,5 times max. stated operating pressure prevailing at customer
Max. operating pressure	M55 100 bar; M54 200 bar
Temperature range	0...70°C for standard version, 0...120°C with remote electronics, 130°C $\leq$ 1 hour allowed for CIP

### Electrical

Power supply	+15...24 Vdc $\pm$ 10%	
Consumption electronics	approx. 80 mA at 15 Vdc	
Consumption valve (if present)	250 mA (max) at 15 Vdc	
Output signal	analog	0...5 (10) Vdc; 2 kOhm min. load
	digital	0 (4)...20 mA (sourcing); 375 Ohm max. load Profibus DP, DeviceNet™, FLOW-BUS, RS232, Modbus-RTU
Command signal	analog	0...5 (10) Vdc; 424 kOhm load
	digital	0 (4)...20 mA (sinking); 250 Ohm load Profibus DP, DeviceNet™, FLOW-BUS, RS232, Modbus-RTU
Electr. connection		male, 8-pin Amphenol for power, analog I/O and RS232
	option	standard M12 connector for Profibus DP (female) or DeviceNet™/FLOW-BUS (male)/Modbus (male)

CE approved design



CORI-FLOW™ Mass Flow Meter with pressure actuated control valve

# CORI-FLOW™ mass flow meter/controller

## › Flow capacity liquid

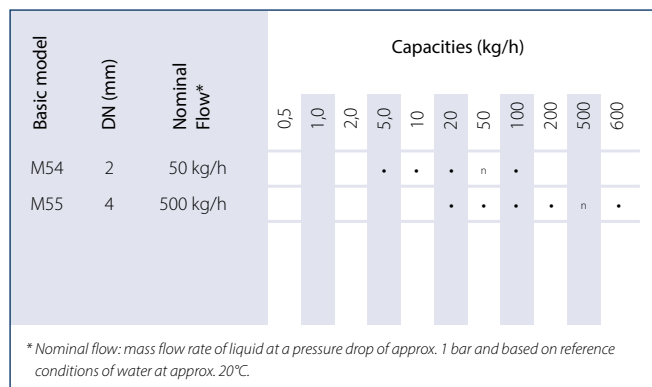

## › Dimensions (mm)

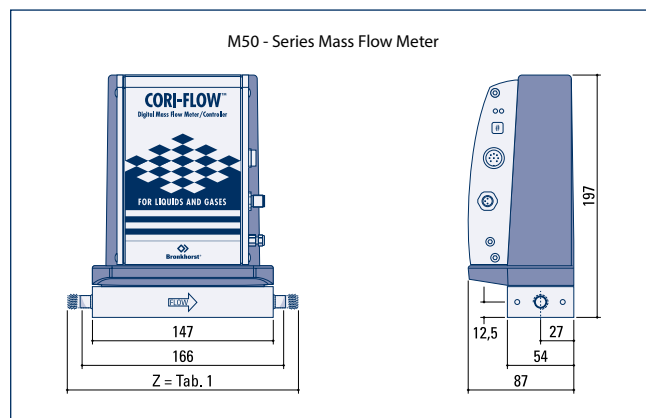

## › Pressure drop liquid (H<sub>2</sub>O)

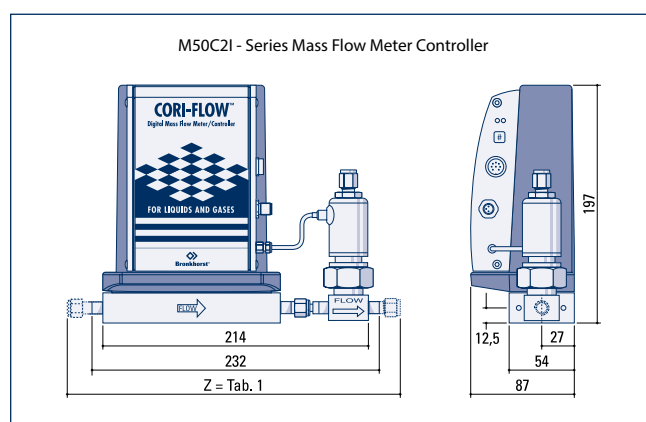
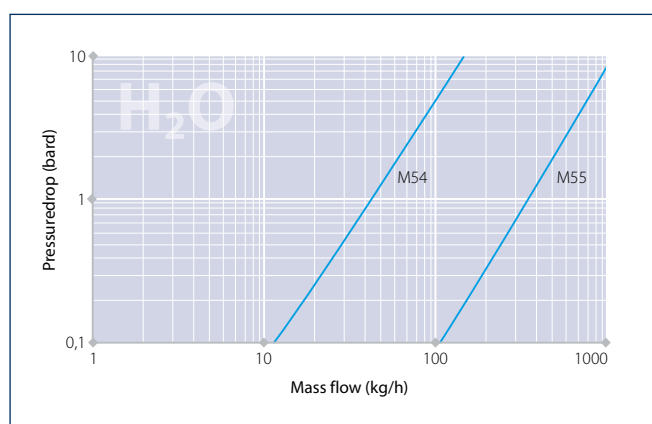

## › Pressure P<sub>1</sub> vs. mass flow for Air (P<sub>2</sub> = 1 bara)

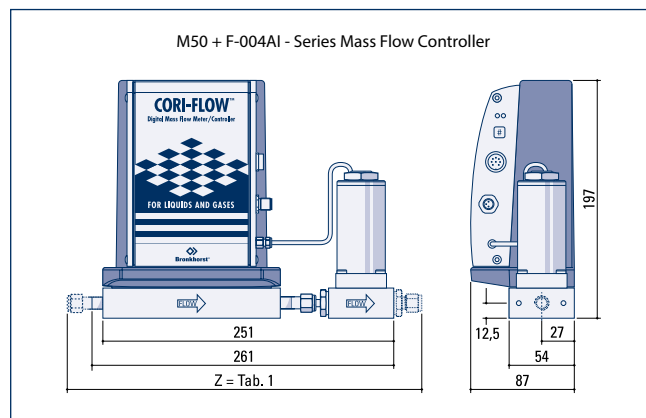
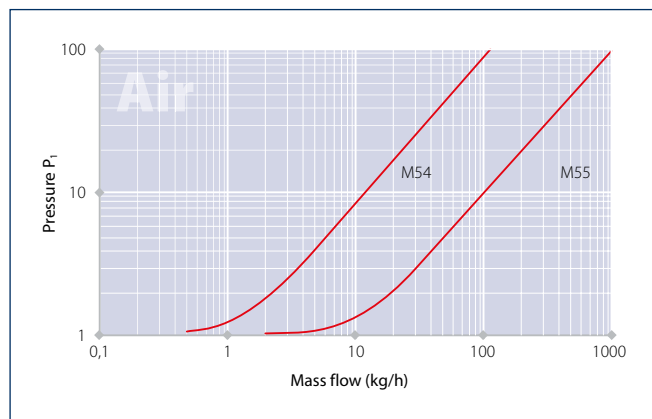

Capacity based on air flow measurement: capacity shown increases with pressure; max. allowable pressure is 100 bara.

## › Table 1 (Z-values in mm)

Connections (in/out)	M50	M50C2/ M50C5I	M50C4
¼" compression type	204	270	306
¼" face seal male	202	267	301
¼" face seal female	202	267	-
6 mm compression type	204	270	306

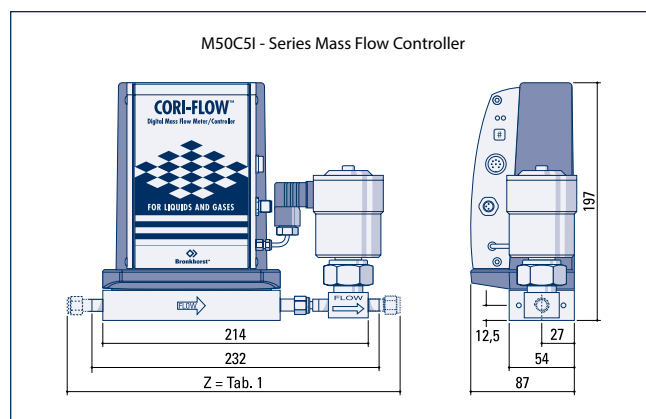

Technical specifications and dimensions subject to change without notice. Dimensional drawings for other MFCs available on request.

# CORI-FLOW™ Applications

## › Applications

The CORI-FLOW™ is suitable for application in industrial environment, laboratories and OEM installations in the following markets (typically):

- ◆ Surface treatment,
- ◆ Energy (fuel cells),
- ◆ Semiconductor industry,
- ◆ Chemical industry,
- ◆ Pharmaceutical industry,
- ◆ Food industry,
- ◆ Optical fibre industry, etc.

## › Critical gas measurement

Fluids like carbon dioxide (CO<sub>2</sub>) and ethylene (C<sub>2</sub>H<sub>4</sub>) are difficult to measure when they are in the interphase stage between being a liquid and a gas. This occurs at temperatures >20°C when pressure ranges from approx. 20 bara to approx. 60...95 bara (depending on temperature).

Under these conditions, physical properties like density ( $\rho$ ) and heat capacity ( $C_p$ ) change very rapidly which makes an accurate mass flow measurement, based on the thermal principle, very difficult. CORI-FLOW™ offers a solution here because of the true mass flow measurement, independent of physical properties. The true mass flow of the molecules is measured, regardless of whether the fluid is in gas phase, in liquid phase or indeed somewhere in between. Experiences in the field have proven that this principle of measuring is very accurate and reliable.

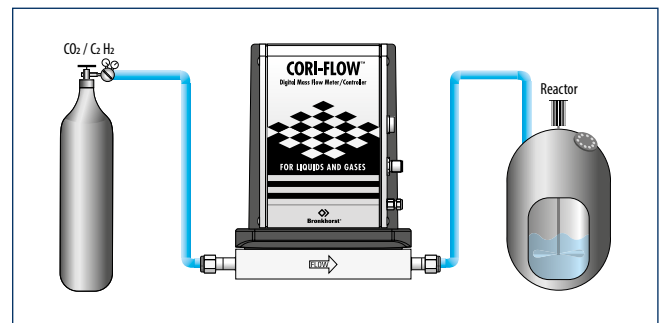

## › CORI-FLOW™ with pump control, PROFIBUS DP operated

By utilising the integrated PID-control function on the CORI-FLOW™ meter, a desired mass flow can be controlled with either a traditional proportional valve or now, more commonly, with a pump as the actuator.

The PID-control to the pump can either be via a direct analogue signal (0...10 V, 0...15 V, 0...20 mA, 4...20 mA) or can be via a voltage/current to frequency converter if this feature is available. The maximum power load for the PID-controller output is ~3,75 Watt. PID-settings for optimal pump control can be set using FlowPlot, a Bronkhorst® tooling program. Most commonly this will be performed in the factory, however, in line with the Bronkhorst® Total Service Concept it is also possible to do this on site.

CORI-FLOW™ instruments can be operated using normal analog signals or via digital interfaces such as RS232 or fieldbus communication. PROFIBUS DP is popular within the process industry as it offers a straight forward connection between a master, a PC or PLC (e.g. Siemens S7-300/400) and its slave devices. Within such a system, the CORI-FLOW™ instrument would act as one of the slave devices and as such would have its control behaviour influenced by the master device. This offers high flexibility in mass flow control.

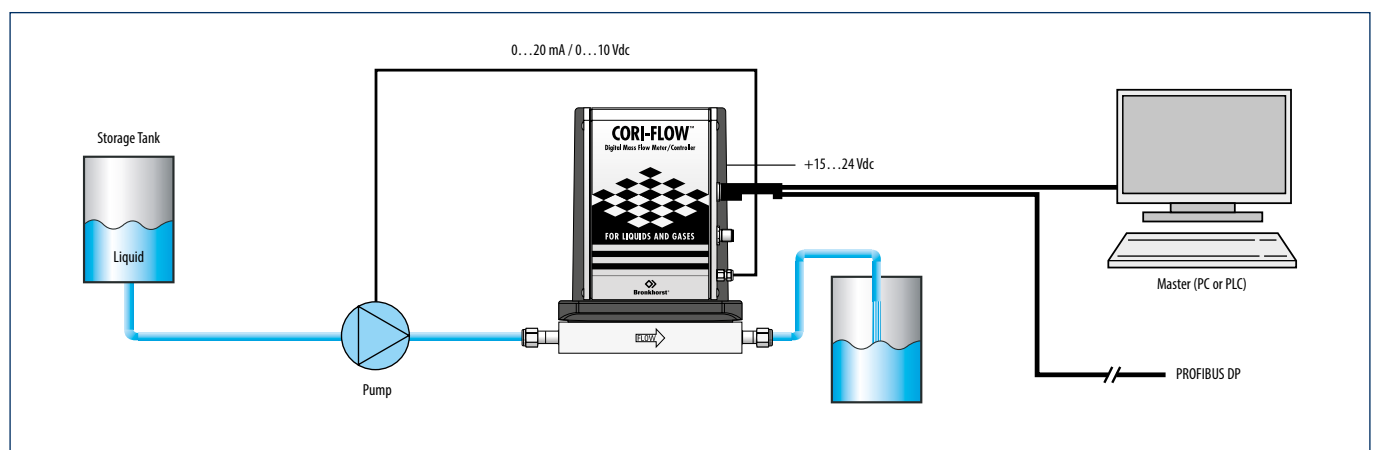

# CORI-FLOW™ Applications

## ► CORI-FILL™ Compact Fluid Dosage Assembly

Each Compact Fluid Dosing Assembly consists of a Coriolis Mass Flow Meter of the CORI-FLOW™ or mini CORI-FLOW™ series and a valve or a pump. The onboard PID-controller of the flow meter will be optimized for controlling the valve or the pump and enables an immediate start of dosage after connecting power and fluid accessories. Just enter the desired flow or batch at the operation module (or remotely by computer) and the compact unit will dose true mass flow, for example independent of ambient temperature and back pressure.

Using the integrated CORI-FILL™ technology, the Coriolis meter's totalizer is capable of highly accurate batch dosage. It also ensures the actuator will react as soon as the batch has (almost) been reached.

Normally several components would be needed to achieve this:

- ◆ Flowmeter
- ◆ Valve/pump
- ◆ Batchcounting module/PLC
- ◆ Software handling these items
- ◆ Weighing scales

CORI-FILL™ offers all this functionality in one component, in one assembly and from one supplier, without the need of complex programming of additional hardware.

More information about CORI-FILL™ applications can be found at [www.cori-fill.com](http://www.cori-fill.com)

CORI-FLOW™ instruments can be used to directly control proportional valves, shut-off valves or pumps, using their integrated PID-controller. Thanks to the CORI-FILL™ technology, highly accurate filling applications are possible using the integrated batch-counter.

Using our standard instruments, maximum flow speed is about 1000 kg/h. This enables filling of 278 gram in 1 second or 16,68 kg per minute. For higher or lower flow rates please consult factory.

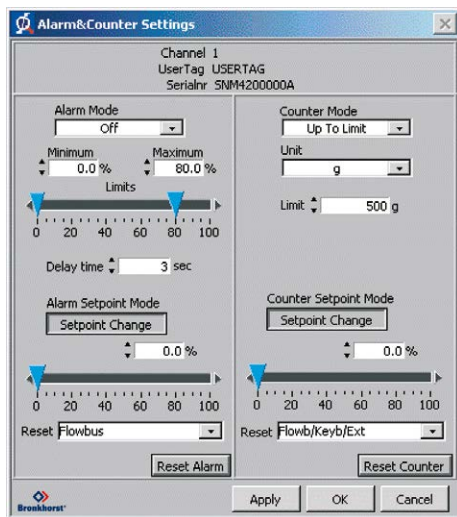
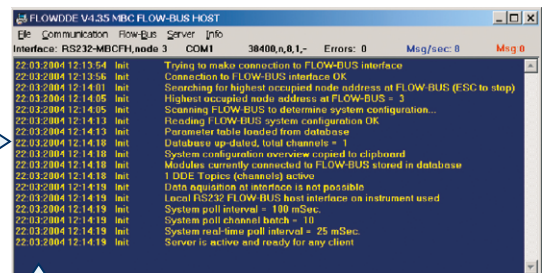
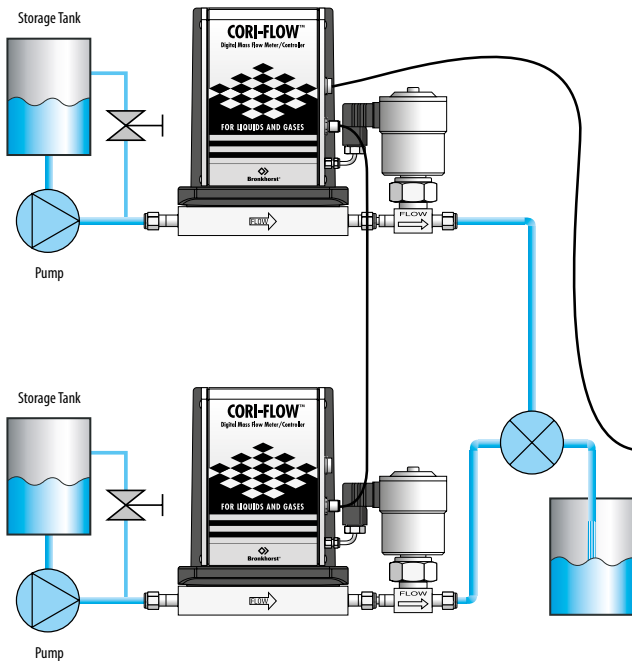

# Model number identification MFM and MFC

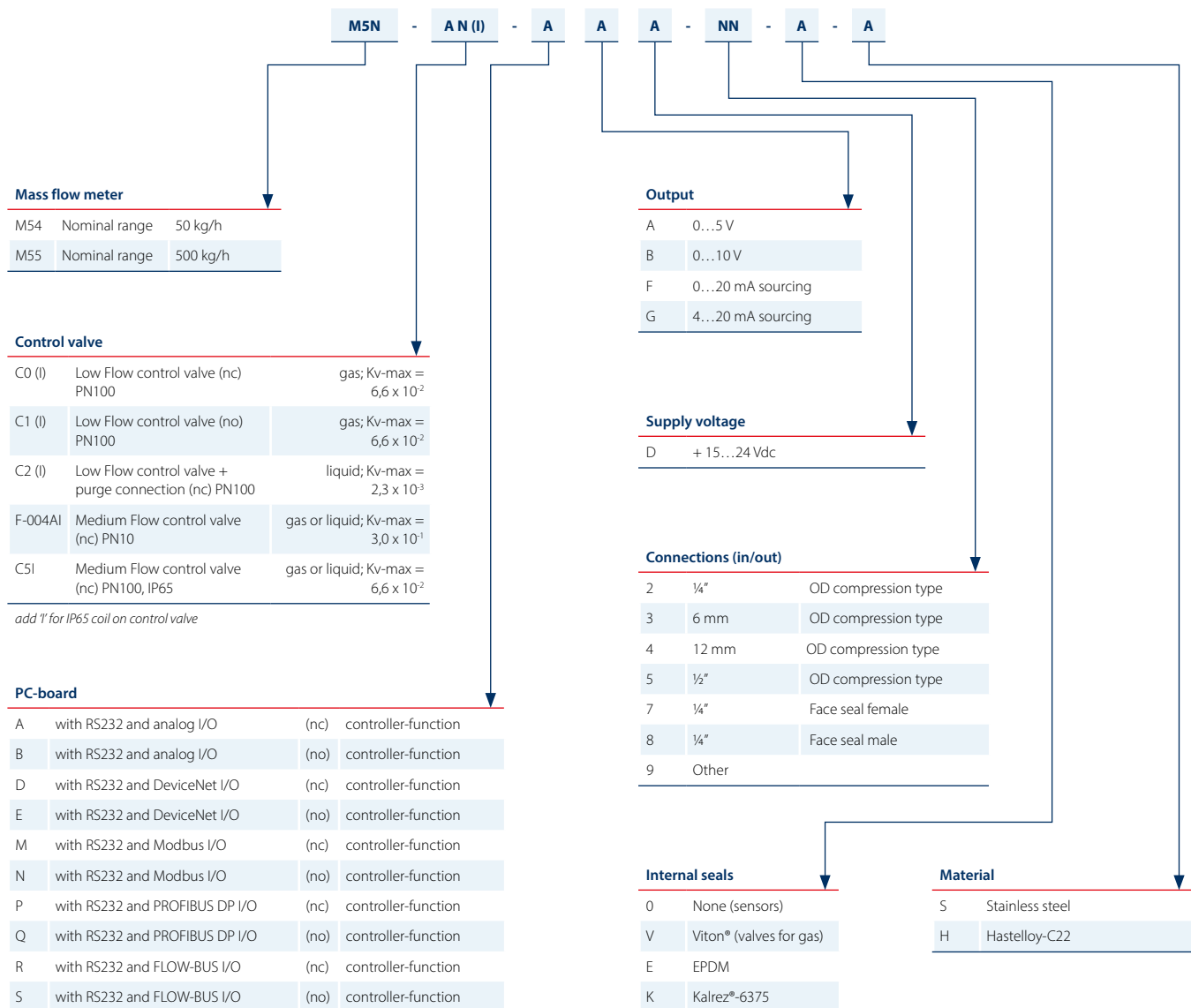

M50C5I series Mass Flow Controllers



CORI-FLOW™ Mass Flow Meter with dosing pump and filter



[www.bronkhorst.com](http://www.bronkhorst.com)

Bronkhorst High-Tech designs and manufactures innovative instruments and subsystems for low-flow measurement and control for use in laboratories, machinery and industry. Driven by a strong sense of sustainability and with many years of experience, we offer an extensive range of (mass) flow meters and controllers for gases and liquids, based on thermal, Coriolis and ultrasonic measuring principles. Our global sales and service network provides local support in more than 40 countries. Discover Bronkhorst®!

**Bronkhorst High-Tech B.V.**  
Nijverheidsstraat 1a  
NL-7261 AK Ruurlo, The Netherlands

Tel. +31 573 458800  
[info@bronkhorst.com](mailto:info@bronkhorst.com)



9.60.032F P2000146 ©Bronkhorst\*