

deltaflow DF12

Data Sheet

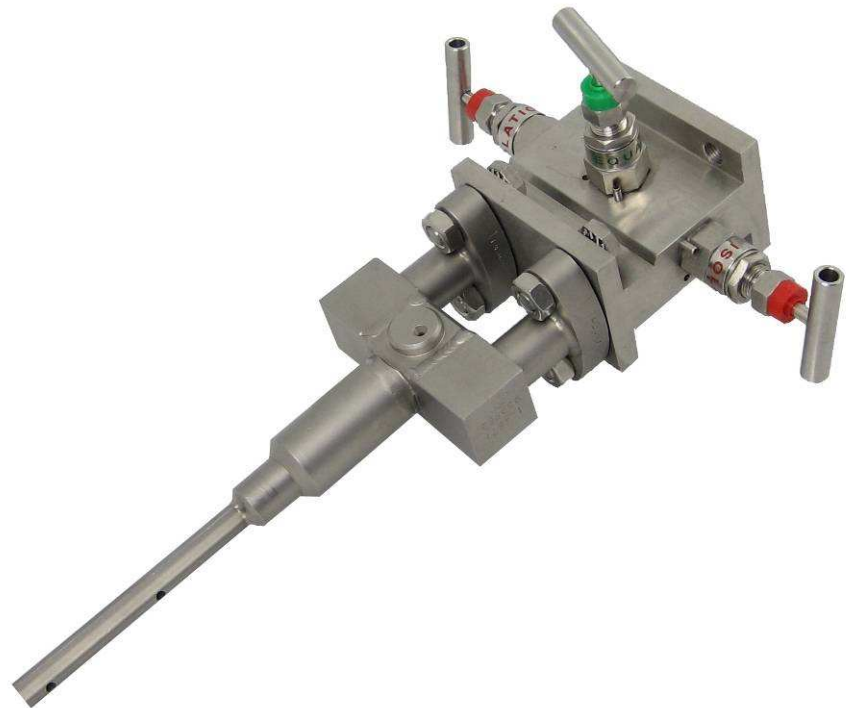

DF12 – Overview

Operational Conditions

- 0 – 160 bar
- -200 – 1240 °C
- DN20 – DN100 (1" – 4")
- Media: Gas, Steam, Liquid
- Accuracy: better 1% ,
When calibrated (e.g. German PTB or factory calibration)
up to 0.5% (on request)
- Bi-directional, Measurement Range > 1:30
- Certifications: Ex / ATEX / 3.1 / 2.2 / PED97/23/EG



Figure 1 DF12 at horizontal pipe, with 3-way-manifold

Materials

- 1.4571 (SS316Ti) (Standard)
- 1.4828 (309) (High temperature)
- 1.4539 (904L), Hastelloy C4, Haynes Alloy (oxidizing materials)
- 1.7380 (A182-F12)
- 1.5415 (A204)
- Others on request



Figure 2 Spool Piece (flange ends) with integrated DF12 with mounted manifold and dp transmitter.

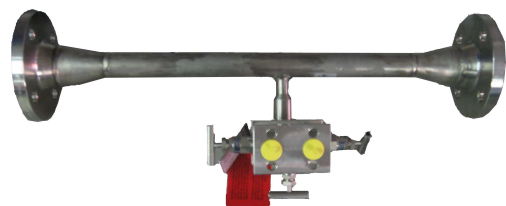

Figure 3 Spool piece with integrated DF12 (with 3-way-manifold) with reduction/widening of pipe for low flow applications.

Accessories

- Differential Pressure Transmitter, Multi Variable Transmitter
- Integrated temperature and/or integrated (static) pressure transmitter
- Weather Protection Box with heater for rough conditions
- Air Purging System LSP (see data sheet LSP) for polluted media (dust load up to 200g/m³)
- Flow Computer flowcom e.g. for measurement of heat transfer

system Controls GmbH
 Lindberghstrasse 4, 82178 Puchheim
 Telefon 089 – 80906-0, Telefax 089 – 80906-200
 eMail: info@system-controls.de
<http://www.system-controls.de>

system
CONTROLS

Liquid Service

In order to consider proper venting or draining location depends on type of media and orientation of pipe. To meter liquids, the entire probe should be filled with liquid allowing gas bubbles to vent off. To allow this to happen, the unit should be installed with a slight downward slope from the dp-transmitter towards the measurement profile

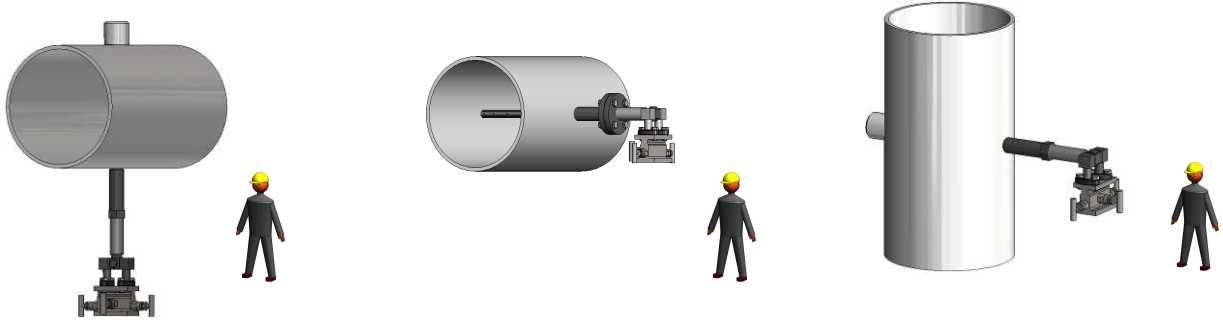

Gas Service

For gasses, the installation theory is exactly opposite to that of liquids. The deltaflow should be completely filled with the gas, and condensation should be able to drain freely back into the conduit.



Steam Service

The deltaflow for steam is always installed into the conduit in a horizontal position. The steam condenses in the connection adapters. The differential pressure is then transmitted across the condensate column to the transducer which is located below it.

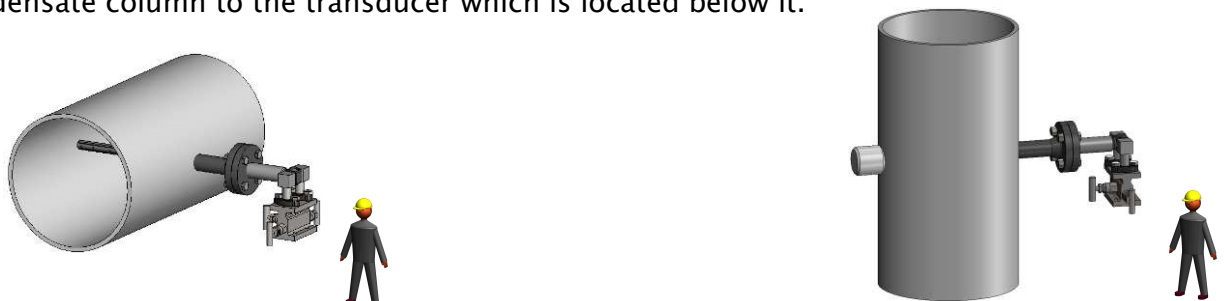

Figure 4 Overview Mounting Possibilities

	Fluid	Process connection	Nominal diameter	Reduction/widening	Inner diameter	Wall thickness	Connection of dp-Transmitter	Connection of Trans. Extra
DF12	-	-	DN ---		ID	WD	-	Designation
	FG							deltaflow pitot tube DF12
	FL							Gas
	FD							Liquid
		CRW						Steam
		CCF						Weld-in Stud with cut-ring PN40
		CMW						Weld-in Stud with Flange PN100
		CMF						Spool Piece with welding ends L=500mm
			DN20					Spool Piece with flange ends L=700mm
			DN25					Nominal Diameter DN20
			DN32					Nominal Diameter DN25
			DN40					Nominal Diameter DN32
			DN50					Nominal Diameter DN40
			DN65					Nominal Diameter DN50
			DN80					Nominal Diameter DN65
			DN100					Nominal Diameter DN80
				R0				Nominal Diameter DN100
				R1				Without Reduction/Widening
				R2				Reduction / Widening 1 Nominal Diameter (only CMW / CMF)
				R3				Reduction / Widening 2 Nominal Diameter (only CMW / CMF)
				R4				Reduction / Widening 3 Nominal Diameter (only CMW / CMF)
				RX				Reduction / Widening 4 Nominal Diameter (only CMW / CMF)
					ID			Other Reduction/Widening on request
						WD		Exact inner diameter [mm]
							AAN	Exact wall thickness [mm]
							AN2	Welding ends (1.4571) (21,3 x 3.2mm)
							AOA	Thread, 1/2"NPT male
							ADW	Ovalflanges for direct transmitter mount (SS316) acc. to. DIN EN 61518
							AKR	Oval flanges and three way manifold for direct transmitter mount (SS316) acc. to. DIN EN 61518
							AEA	Ball valve 1/2" female SS
							AEN	Needle valve welding ends, SS316 (21.3 x 3.2mm)
							AKO	Needle valve 1/2" NPT female
							AXX	Oval flanges (acc. To DIN EN61518) on ball valve for direct transmitter mount SS316
							AER	Others on request
							ASW	Ermeto fitting (Standard size 10mm)
								Swagelock fitting

Mounting Material	Material of Probe Profile	Isolation of Pipe	Nominal pressure	Orientation of Pipe	Orientation of Flow
MCX					Designation Carbon Steel
MES					V4A, 14571, SS316Ti (CRW / CCF)
MEM					V4A 1.4571 SS316ti (CMW / CMF)
MXM					16 Mo 3 (mit CMW/CMF)
MXF					16 Mo 3 (with Option CCF)
MXH					1.4828 (with Option CCF)
MXG					1.4828 / 1.4841 (with Option CMW / CMF)
MXX					Others on request
SEE					Profile 1.4571
SVE					Profile 1.4539 / Probe 1.4571
SXE					Profile 1.4828 / Probe 1.4571
SXX					Others on request
	X075				Insulation <75mm
	XXXX				Others on request
		PN0016			PN16 (with Option CMF)
		PN0040			PN 40 (with Option CMF)
		PN0064			PN 64 (with Option CMF)
		PN0100			PN 100 (with Option CMF)
		PN0160			PN 160 (with Option CMF)
		PN0250			PN 250 (with Option CMF)
		AN0150			ANSI 150lbs (with Option CMF)
		AN0300			ANSI 300lbs (with Option CMF)
		AN0400			ANSI 400lbs (with Option CMF)
		AN0600			ANSI 600lbs (with Option CMF)
		AN0900			ANSI 900lbs (with Option CMF)
		AN1500			ANSI 1500lbs (with Option CMF)
				OV	Pipe vertical
				OHO	Pipe horizontal, installation from top (only for dry gases!)
				OHS	Pipe horizontal, installation from side (for option FG/FD)
				OHU	Pipe horizontal, installation from bottom (only for option FL)
				OXX	Other orientation of pipe, please clarify
				RVO	Vertical pipe, flow from top (just required if CMF/CMW and integrated P and or T)
				RVU	Vertical pipe, flow from bottom (just required if CMF/CMW and integrated P and or T)
				RHR	Horizontal pipe, flow from right (just required if CMF/CMW and integrated P and or T)
				RHL	Horizontal pipe, flow from left (just required if CMF/CMW and integrated P and or T)
				RXX	Other orientation of flow, please clarify

Thermometer	EX Certificate f. Thermometer	Pressure Gauge	EX Certificate for press. gau.	Options	Customized Options	Designation
T1						Thermometer (separatly supplied), PT100, inkl mounting stud G1/2" bzw. G1/4"(max. 600°C)
T2						Thermometer (separatly supplied), PT100, incl. Transmitter 4..20mA, incl. Mounting stud G1/2" or G1/4" (max. 600°C)
T3						Thermometer (separatly supplied), Thermoelement Typ K, incl. transmitter 4..20mA and mounting stud (max. 1000°C)
T4						Integrated Thermometer, PT100, max. 600°C (only CMF/CMW)
T5						Integrated Thermometer, PT100, incl. transmitter 4...20mA,max. 600°C (only CMF/CMW)
T6						Integr. Thermometer, Thermo element Typ K, incl. transmitter 4..20mA, incl mounting stud (max. 1000°C) (only with CMF/CMW)
TX						Customized Thermometer, please specify
EXT0						Thermometer without Ex certification
EXT1						Thermometer with Ex Certification (Ex ia)
	P01					Integrated G1/2" stud for pressure gauge (only CMW/CMF)
	P02					Integrated G1/2" stud for pressure gauge incl. Shut-off valve G1/2" (only CMW/CMF)
	P03					Integrated G1/2" stud for pressure gauge incl. Shut-off valve G1/2" and siphon (only CMW/CMF)
	P1					Integrated Pressure Gauge 4..20mA (only CMW/CMF)
	P2					Integrated Pressure Gauge 4..20mA, incl. shut-off valve (only CMW/CMF)
	P3					Integrated Pressure Gauge 4..20mA, incl. shut-off valve and siphon (only CMW/CMF)
	P4					Pressure Gauge 4...20mA (separatly supplied) incl. Mounting stud G 1/2"
	P5					Pressure Gauge 4...20mA (separatly supplied) incl. Mounting stud G 1/2" and shut-off valve
	P6					Pressure Gauge 4...20mA (separatly supplied) incl. Mounting stud G 1/2", shut-off valve and siphon
	PX					Customized pressure gauge, please specify
	EXP0					Pressure Gauge without Ex certification
	EXP1					Pressure Gauge with Ex certification (Ex ia)
				3_1		Material certificate EN 10204
				2_2		Factory material certificate EN 10204
				Ptest	Z	Factory pressure test 1,5 times nominal pressure Customized Options – please state in clear words

Table 1 DF12 Type Code

Example for Order using model code:

DF12-FG-CMF-DN80-R0-78.3mm-3.2mm-ADW-MCX-SEE-X075-PN0016-OHS-RHR-T4-EXT0-P3-EXP0

system Controls GmbH
 Lindberghstrasse 4, 82178 Puchheim
 Telefon 089 – 80906-0, Telefax 089 – 80906-200
 eMail: info@system-controls.de
<http://www.system-controls.de>



Type Code in Detail

Fluid

Code	Designation
-FG	Please select option FG (Gas) if your medium is a gas
-FL	Option FL (liquid) is the correct choice if your medium is a liquid and if boiling (flashing) is not a consideration in either the conduit or the ambient temperature. This category includes the most common liquids such as water, hydrocarbons, etc. Flashing is not generally an issue except in situations involving high temperatures or liquid gasses.
-FD	If your medium is (water-based) steam, then Option FD is the correct choice.

Table 2 Model Code – Media

If your medium happens to be multi phase (such as cryogenic gas or wet steam), we will be happy to help you find a workable solution. Please contact us.

If your medium is heavily polluted, we would also be happy to help you with our automatic air purging system LSP (see data sheet LSP). We recommend using LSP whenever particle load exceeds 50–60mg/m³. In most applications *deltaflow operates satisfactorily without cleaning and without maintenance.*

Process Connection

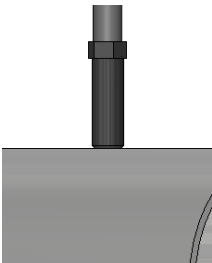
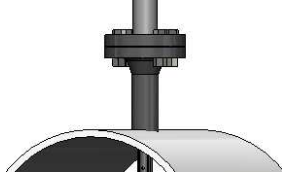
Code	Illustration	Designation
-CRW		Option CR (weld-in stud with cut ring) is the easiest and most economical way to install your deltaflow into a conduit. Simply drill a hole in the conduit, weld the stud into place and insert the deltaflow until it touches the opposite side of the conduit. Tighten the coupling nut, and you are finished. The compression ring stud can be used up to PN40.
-CCF		Weld-in stud flange (option CCF) are often used in gauge pressure applications. This model is also well suited to high pressure situations, because the flange uses 4 or more mechanically redundant screws to hold the deltaflow in position. The flange is designed to divert pressure in the event of a leak, thereby preventing media from spurting in the direction of the operator. This means that the flange connection method provides an added measure of safety when the deltaflow is used to meter dangerous media under pressure, such as steam.



-CMW		<p>When choosing this option your DF12 will be come integrated in a spool piece¹⁾ which will be then welded in your existing pipe (spool piece with welding ends). The standard length of the spool piece is 500mm. As a standard the DF12 will be welded into the spool piece (other connections available, please specify)</p>
-CMF		<p>When choosing this option your DF12 comes welded in¹⁾ a spool piece, which will be then flanged in your existing pipe (spool piece with flange connections). The standard length of your spool piece is 700mm (other lengths on enquiry). As a standard the DF12 will be welded into the spool piece (other connections available, please specify)</p>

Table 2 Model Code – Process Connections

¹⁾ Depending on the flow data there might have to be used flange studs as a process connection to stay in compliance with the PED 97/EC

Nominal diameter

The deltaflow DF12 can be used within the nominal diameter range from DN20 through DN100 (1" to 4"). For other diameter measurements, please select a different deltaflow model (DF8 / DF25 / DF44 / DF50).

Code	Designation
-DN...	Please specify the nominal diameter of your conduit (metric or ANSI units).

Table 3 Model Code – Nominal Diameter

Reduction

Please choose the desired reduction. Nominal reduction means that the size of the spool piece (the place where the integrated deltaflow is) will be smaller then the nominal diameter of your existing tube. The pipe will be reduced starting from your pipe, at the end of the spool piece It will be widened back to your pipe's diameter. Typically, this option is used for very low velocities in order to increase the velocity. If it is necessary for your application, it will be checked and calculated by systec Controls or a authorized distributor

Code	Illustration	Designation
-R0		No reduction. Diameter of the spool piece is consistently the same as your tubes diameter.
-R1		Reduction by one nominal diameter. (for example: your pipe is DN100 and must be reduced to DN80). The standard length of the spool piece is 700mm (other lengths on request).
-R2		Reduction by two nominal diameter. (for example: your pipe is DN100, it must be reduced to DN65). The standard length of the spool piece is 700mm (other lengths on request)
-R3		Reduction by three nominal diameter. (for example: your pipe is DN100, it must be reduced to DN50). The standard length of the spool piece is 700mm (other lengths on request)
-R4		Reduction by four nominal diameter. (for example: your pipe is DN100, it must be reduced to DN20). The standard length of the spool piece is 700mm (other lengths on request)
-RX		Other reduction/widenings on request

Table 5 Spool Piece – Nominal Diameter Reduction

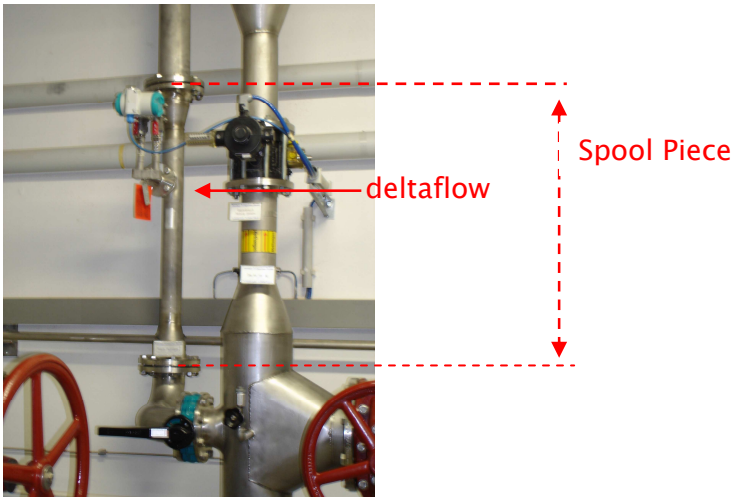

Figure 5 example of a deltaflow integrated in spool piece

Inner Diameter

Code	Illustration	Designation
-ID...		<p>Your deltaflow is custom-built. In order to assure that your deltaflow is ideally suited to your application, we need to know the actual interior diameter and the wall thickness of your conduit. We recommend that this measurement not be taken from your documentation, but rather measured—at the planned sampling site if possible. This is particularly important for applications involving older conduit systems. It is NOT necessary to have this measurement at the bid proposal stage, but it will be required at the time the order is placed.</p>

Table 1 Code – Inner Diameter

Wall Thickness





Code	Illustration	Designation
-WD...		<p>Your deltaflow is custom-built. In order to assure that your deltaflow is ideally suited to your application, we need to know the actual interior diameter and the wall thickness of your conduit. We recommend that this measurement not be taken from your documentation, but rather measured—at the planned sampling site if possible. This is particularly important for applications involving older conduit systems. It is NOT necessary to have this measurement at the bid proposal stage, but it will be required at the time the order is placed.</p>

Table 2 Code – Wall Thickness

dp-connection

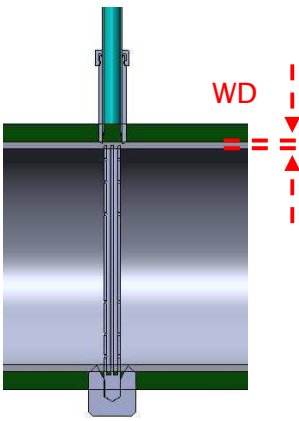
The dp connection you select establishes the way in which you would like to transfer the differential pressure metered at the deltaflow to your dp-transmitter

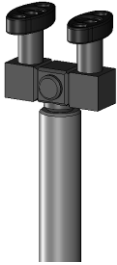
Code	Illustration	Designation
-AAN		<p>With option AAN you will get your deltaflow with welding ends. Here you have to take care about the connection to your transmitter (impulse piping). Can be used for all kind of media.</p>

<p>-AN2</p>		<p>If you enter option AN2, your deltaflow will come equipped with ½” NPT external thread connections. Here you have to take care about the connection to your transmitter (impulse piping). Can be used for all kind of media.</p>
<p>-AOA</p>		<p>If you select option AOA, your deltaflow will be equipped with a flange connection acc. to DIN 19213. Advantage: this feature will allow you to flange most differential pressure transducers directly to the unit without any additional signal conduit. This can save a great deal of time and money. Appropriate for use with all media.</p>
<p>-ADW</p>		<p>In addition to the flange connection (option AOA), the option ADW also comes equipped with a three-way manifold mounted on top of the unit. The three-way manifold makes it possible to install and uninstall the dp-transmitter during operation. It also enables you to conveniently perform a zero-point alignment without interrupting your process.</p>
<p>-AKR</p>		<p>If you select option AKR, you will receive high grade steel ball valves with R ½” internal threads. This is generally used with Humid gasses (no capillary effect) when the dp transmitter is to be installed seperately from the probe. Ball valves can be used up to 70bar (35°C) / 200°C (2 bar).</p>



-AEA		If you order option AEA, your probe will come equipped with a stainless steel needle valve with welding ends (21.3x3.2mm)
-AEN		If you order option AEA, your probe will come equipped with a stainless steel needle valve with thread connection (1 / 2" NPT female)
-AKO		Option AKO (oval flanges on ball valves) is used primarily for humid gasses (i.e. flue gas after scrubber, biogas etc). If you order your deltaflow with this option, you will be able to mount your dp-transmitter directly onto the oval flanges, and you will also have a completely capillary-free probe. In other words, any condensation which forms can flow freely back into the conduit. This is significant for achieving high levels of precision. Ball valves can be used up to 70bar (35°C) / 200°C (2 bar).
-AXX		Customized Solution. Please use this option if you need special connection and specify what exactly you need. If you choose this option pls. confer with systec Controls or your local distributor

Table 3 Model Code – Mounting Material

dp-connection Extra

Code	Illustration	Designation
-AER		Ermeto fitting 10mm (other sizes on request)
-ASW		Swagelock fitting

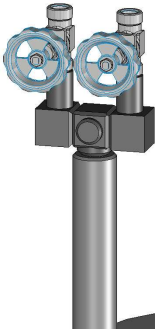
Table 4 Model Code – Connection of dp-Transmitter Extra

Mounting Material

Unless you intend to use an existing connection stud, your deltaflow will be delivered with all studs required for Installation (see also *process connection*). You must select the material for these studs that is appropriate to your application (normally chosen material should be similar to pipe material). You have following options:

Code	Designation
-MCX	Material: Carbon steel (St35.8 or similar) A standard delivery includes weldable stud / spool piece made of carbon steel. St35.8 material can be welded to almost all common carbon steel pipe systems with no problems. Appropriate for use in normal to high temperature ranges (up to 450° C) and under normal to medium pressures. Non-corrosive—or relatively non-corrosive— media (air, steam, water).
-MES	Mounting material stainless steel (V4A, 1.4571, SS316ti o.ä.) (für stud (option CRW/CRR)). For use under more corrosive conditions the stud could be manufactured in stainless steel. This is usually necessary if the conduits are also constructed of high grade steel. Appropriate for use in normal to normal up to high temperatures (up to 550°C) and under normal to high pressures (up to PN160). Corrosive media (salt water, gasses containing HCl).
-MEM	Mounting material stainless steel (V4A, 1.4571, SS316ti o.ä.) (for spool piece (option CMFW/CMW)). For use under more corrosive conditions the spool piece could be manufactured in stainless steel. This is usually necessary if the conduits are also constructed of high grade steel. Appropriate for use in normal to high temperatures (up to 550°C) and under normal to high pressures (up to PN160). Corrosive media (salt water, gasses containing HCl).
-MXM	Mounting material 16Mo3 (für spool piece (option CMF/CMW)) This material is primarily used in steam and feedwater applications at extreme temperatures and pressures.
-MXF	Mounting material 16 Mo 3 ((with Option CCF)
-MXH	Mounting material 1.4828 (309) for high temperatures (up to 1040°C) . Moderate chemical resistance. Widely used e.g. for live steam application in power plants.
-MXG	Material 1.4828 / 1.4841 (with Option CMW / CMF) for high temperatures
-MXX	Other materials available on request

Table 4 Model Code – Mounting Material

Other materials may also be available; do not hesitate to ask. Please be prepared to tell us what materials are used in your existing pipe system, and we will then research to determine if the appropriate installation material is available and whether it is suitable for welding.

Material of Profile / Probe

deltaflow's patented profile plays a significant role in the flowmeter's accuracy. Because the profile is surrounded by flowing medium, the mechanical and chemical demands placed on the equipment are especially great. For this reason, the deltaflow is always constructed of premium high-grade steel (1.4571, V4A, 316Ti). It is also possible to use an even higher-quality construction material

system Controls GmbH
Lindberghstrasse 4, 82178 Puchheim
Telefon 089 – 80906-0, Telefax 089 – 80906-200
eMail: info@system-controls.de
<http://www.system-controls.de>

system
CONTROLS

for the profile and the rest of the pitot tube (which is not surrounded by the flowing medium and which therefore does not need such a high resistance) to meet special needs.

Code	Illustration	Designation
-SEE		<p>Flow profile made of high-grade steel (1.4571, V4A, SS316Ti). Standard material, appropriate to most applications and media (gas, steam, and liquids). Resistant to moderate levels of corrosion, and to temperatures up to approximately 600° C.</p> <p>Good solidity. Not appropriate for use in applications where smoke and exhaust contain sulfur particulates (risk of pitting corrosion).</p>
-SVE		Profile made of 1.4539 (high chemical resistance) / probe made of 1.4571
-SXE		Flow profile made of high-temperature steel 1.4828 (309) probe made of 1.4571 (SS316Ti). High temperature resistance, moderate chemical resistance. Appropriate for use up to 1040° C. High mechanical stability at high temperatures. Can be used, for example, in superheated and live steam up to 650° C (i.e., in power plants).
-SXX		If you need other materials, we will be happy to help you. Please contact systec- Controls or your systec-dealer.

Table 5 Type Code – Profile–/ Probe Material

Insulation

Code	Illustration	Designation
-X075		The insulation of your conduit is less than 75mm.
-XXXX		For insulations beyond 75mm please ask systec- Controls or your systec- dealer.

Table 5 Model Code – Insulation

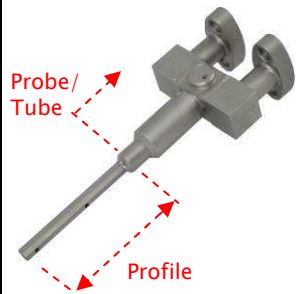
Nominal pressure for spool pieces with flange ends as pipe connections (option CMF)

You have it only to indicate, if you have chosen CMF as mounting option (spool piece with flange ends). The flange ends of the spool piece will be adapted to the nominal pressure stage of your application



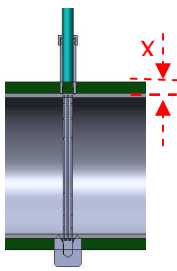

Code	Designation
-PN... (-AN....)	In order to insure that pressure-bearing parts of the deltaflow meet your requirements, please specify the pressure level within your pipe conduits (use PN for DIN pipes; use lbs. for ANSI pipes). The standard pressure level of the deltaflow is PN16 and the DF12 is available up to PN160. Please choose the pressure stage of the flange according to the process connection (option spool piece CMW/CMF)

Table 6 Model Code – Pressure Stage for spool pieces

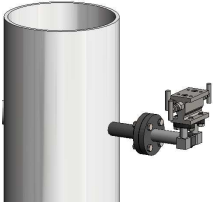
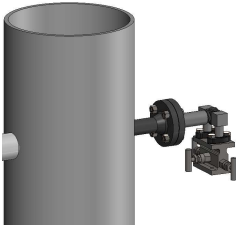
Pipe Orientation

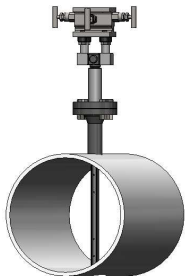
Depending your pipe orientation, the installation position and the medium, the connections of the deltaflow will be manufactured differently in order to allow condensation to drain freely back into the conduit (gas service, steam service) or allowing gas bubbles to vent off (liquid service)

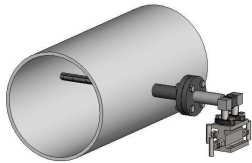
Code	Illustration	Designation
-OV Medium Gas (FG)		To meter gas in vertical conduits, the deltaflow is always installed in a horizontal position with a slight slant (0..3°) toward the point of the probe (tip of deltaflow is at lower position as flange side). The dp connections are designed at an upward-facing angle. This allows any resulting condensation to easily drain back into the conduit.
-OV Medium Liquid (FL)		In vertical conduits, the deltaflow is always installed in a horizontal position with a slight upward slant (0..3°) (tip of deltaflow at higher position than flange side) The dp connections are designed at an angle, facing downwards. This allows gas bubbles to vent-off.

<p>-OHO Medium Gas (FG)</p>		<p>For horizontal conduits, we recommend that you install your deltaflow into the pipe from above (12 o'clock position) when you meter dry gases. For wet gases we recommend installation from side</p>
<p>-OHS Medium Gas (FG)</p>		<p>It is also possible to install the deltaflow for gas in a horizontal position (3 o'clock position) in horizontal conduits. An incline of 0..3° should be maintained (tip of deltaflow at lower position than flange side) to allow condensation to drain. Connections are installed at right angles facing upwards.</p>
<p>-OHS Medium Liquid (FL)</p>		<p>It is also possible to install the deltaflow for liquid horizontally (3 o'clock position) in horizontal conduits. A slight incline toward the point of the probe should be maintained in order to allow gas to vent-off (tip of deltaflow at higher position than flange side, incline of 0..3°)</p>
<p>-OHU Medium Liquid (FL)</p>		<p>For horizontal conduits, we recommend that you install your deltaflow for liquids into the conduit from below (6 o'clock position). This ensures that air can vent-off.</p>
<p>-OHS Medium Steam(FD)</p>		<p>The deltaflow for steam is always installed horizontally with a slight upward slant (0..3°) (tip of deltaflow at a higher position than flange side). The water-filled impulse lines lead downward to the transmitter (transmitter has to be at lower position, there should be a continuous incline between deltaflow and transmitter when using impulse pipes).</p>

<p>-OV Medium Steam (FD)</p>		<p>The deltaflow for steam can be also installed horizontally in vertical conduits, with a slight slant (0..3°) (tip of deltaflow at a higher position than flange side). The water filled impulse lines lead downward to the transmitter (transmitter has to be at lower position, there should be a continuous in-line between deltaflow and transmitter when using impulse lines).</p>
---	---	---

Table 7 Code – Pipe Orientation

Pipe orientation 2

If you order your DF12 in a spool piece (option CMF / CMW) also with temperature- and pressure-measurement (option T... / P...), please state the flow direction in your conduit. For your information: the (external) temperature measurement is located always behind (outlet) the DF12, the pressure measurement in front (inlet) of the pitot tube to get no influence on the measurement.

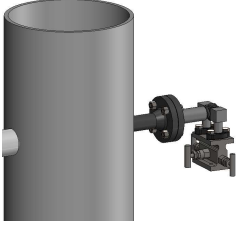

If you order the deltaflow without spool piece respectively with spool piece but without temperature or pressure- measurement it is not necessary that you indicate the “pipe orientation 2”.

Code	Designation
-RVO	You have a vertical pipe, the flow direction is top to down.
-RVU	You have vertical duct, the flow direction is bottom-up.
-RHR	You have a horizontal pipe, your flow direction is from right to left.
-RHL	You have a horizontal pipe, your flow direction is from left to right.

Table 8 Code – Pipe Orientation 2

Temperature Measurement

There is the possibility to integrate a temperature meter and/or a meter for static pressure in your deltaflow when using spool piece (option CMW/CMF). Also there are also external screw-in meters with mounting material available when ordering DF12 without spool piece.

Code	Illustration	Designation
-T1		Thermometer, PT100, incl. G 1/2" or G 1/4" mounting stud (max. 400°C). The thermometer and the mounting stud will be provided separately for self mounting.
-T2		Thermometer, PT100, incl. 4-20mA transmitter, incl. G 1/2" or G 1/4" mounting stud (max. 400°C). The thermometer and the mounting stud will be provided separately for self mounting.
-T3		Thermometer, thermocouple Typ K, incl. 4-20mA transmitter, incl. G 1/2" or G 1/4" mounting stud (max. 400°C). The thermometer and the mounting stud will be provided separately for self mounting.
-T4		Thermometer, PT100, incl. G 1/2" mounting stud (max. 600°C). The thermocouple is integrated in the spool piece outlet. This option is only possible in connection with a spool piece (option CMF/CMW).
-T5		Thermometer, PT100, incl. 4-20mA transmitter, incl. G 1/2" mounting stud (max. 400°C). The thermocouple is integrated in the spool piece outlet. This option is only possible in connection with a spool piece (option CMF/CMW).

-T6		Thermometer, thermocouple Typ K, incl. 4–20mA transmitter, incl. mounting stud (max. 1000°C). The thermocouple is integrated in the spool piece outlet. This option is only possible in connection with a spool piece (option CMF/CMW).
-TX		Other temperature measurements on enquiry. Please specify.



Table 9 Code – Thermometer





Ex-approval for temperature measurement

Code	Bild	Designation
EXT0		Thermometer will be delivered without Ex-approval
EXT1		With Ex-approval EEx ia IIC T6

Table 9 Model Code – ATEC Certification for thermometer

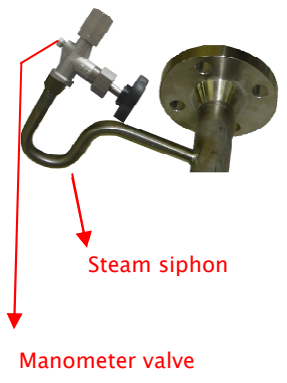
Integrated pressure measurement

Code	Illustration	Designation
-P01		Preparation for pressure measurement with mounting stud and adapter sleeve (R/L thread G ½“). The mounting stud is integrated in the flow inlet- or outlet direction. The pressure transmitter will be provided by the customer. This option is only available in connection with a spool piece (option CMF/CMW).
-P02		Preparation for pressure measurement with mounting stud and adapter sleeve (R/L thread G ½“) with manometer valve. The mounting stud is integrated in the flow inlet- or outlet direction. The pressure transmitter will be provided by the customer. This option is only available in connection with a spool piece (option CMF/CMW).

<p>-P03</p>		<p>Preparation for pressure measurement with mounting stud and adapter sleeve (R/L thread G ½“) with manometer shutoff valve and steam siphon. The steam siphon is integrated in the flow inlet- or outlet direction. The pressure transmitter will be provided by the customer. This option is only available in connection with a spool piece (option CMF/CMW).</p>
<p>-P1</p>		<p>Integrated absolute transmitter (4...20mA) with two-wire connection, without shut-off valve counterpart to the medium. The pressure transmitter is integrated in the flow inlet- or outlet direction. This option is only available in connection with a spool piece (option CMF/CMW).</p>
<p>-P2</p>		<p>Integrated absolute transmitter (4...20mA) with two-wire connection, with manometer shutoff valve. The pressure transmitter is integrated in the flow inlet- or outlet direction. This option is only available in connection with a spool piece (option CMF/CMW).</p>
<p>-P3</p>		<p>Absolute pressure transmitter (4...20mA) with two wire connection, incl. steam siphon (must be chosen when having steam service) with manometer shut-off valve. The pressure transmitter is integrated in the flow inlet- or outlet direction. This option is only available in connection with a spool piece (option CMF/CMW).</p>



<p>-P4</p>		<p>Absolute pressure transmitter (4...20mA) with two wire connection, with mounting stud G ½". The transmitter and the mounting stud will be enclosed separately.</p>
<p>-P5</p>		<p>Absolute pressure transmitter (4...20mA) with two wire connection, manometer shut off valve incl. mounting stud G ½" and adapter sleeve. The transmitter and the mounting stud will be enclosed separately for self mounting.</p>
<p>-P6</p>		<p>Absolute pressure transmitter (4...20mA) with two wire connection, manometer shut off valve, incl. mounting stud G ½" and adapter sleeve. The transmitter, manometer shut off valve and the steam siphon will be enclosed separately for self mounting (for welding). The option steam siphon must be chosen if you have steam as medium to generate a water column which is necessary to operate a dp- transmitter at a steam application.</p>
<p>-PX</p>		<p>Other pressure transmitters on enquiry. Please specify.</p>

Table 9 Model Code – Pressure measurement

Ex-approval for pressure measurement

Code	Designation
EXP0	Pressure transmitter will be delivered without Ex- approval
EXP1	Pressure transmitter with Ex-approval EEx ia IIC T4

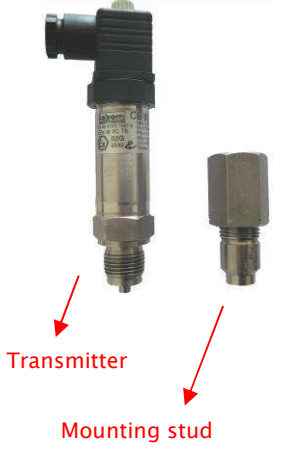
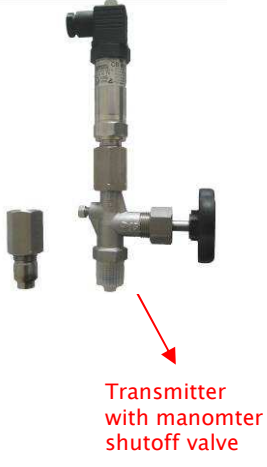
Table 10 Model Code – ATEX Certificate for pressure measurement

Options

Code	Designation
-3.1	Material Certificate acc. To EN 10204 with batch numbers of all used materials. With that option all materials are fully traceable back to steel mill.
-2.2	Factory Certificate acc. To EN10204. This certificate is issued by systec- Controls and confirms that this deltaflow was made of a special (desired) material.
-Ptest	Pressure Test with test certificate. Pressure test will be conducted with 1.5 times of your pressure.

Table 12 Model Code – Options

Customized Options

Code	Designation
-Z	If you need any customized options we would ask you to clarify with your systec dealer and state in clear words in your order.

Upstream & Downstream Distances with/without use of ImproveIT

The new ImproveIT database makes it possible to use the deltaflow in applications where the inlet runs are very short (see also deltaflow product brochure for further informations. The following table shows upstream and downstream distances (in multiples of inner pipe diameter DI) and the corresponding accuracies when using ImproveIT. [No improveIT possible in case of valves and pumps possible]

Mounting Situation	Expected Accuracy	Without Improve IT		Using Improve IT	
		Inlet A	Outlet B	Inlet A	Outlet B
	0,5%	14 x DI	3 x DI	7 x DI	3 x DI
	1,0%	7 x DI	3 x DI	4 x ID	3 x ID
	2,0 %	4 x DI	2 x DI	1 x DI	2 x DI
	0,5%	18 x DI	3 X DI	7 x DI	3 x DI
	1,0%	9 x DI	2 x DI	4 x ID	3 x ID
	2,0 %	5 x DI	2 x DI	2 x DI	1 x DI
	0,5%	14 x DI	3 x DI	7 x DI	3 x DI
	1,0%	7 x DI	3 x DI	4 x D	3 X D
	2,0 %	4 x DI	2 x DI	1 x DI	1 x DI
	0,5%	14 x DI	3 x DI	8 x DI	3 x DI
	1,0%	7 x DI	3 x DI	4 X D	3 X D
	2,0 %	4 x DI	2 x DI	2 x DI	1 x DI
	0,5%	36 x DI	6 x DI		
	1,0%	24 x DI	4 x DI		
	2,0 %	12 x Di	3 x DI		
	0,5%	24 x DI	6 X DI	12 x DI	3 x DI
	1,0%	17 x DI	4 x DI	7 x D	3 x D
	2,0 %	9 x DI	3 x DI	2 x DI	2 X DI

Table 11 Required Upstream & Downstream Distances

Further Information

www.systec-controls.de -> Products -> deltaflow

- deltaflow product brochure
- deltaflow Installation guide
- deltaflow calculation basics
- deltacalc calculation software for primary elements
- Data sheets of deltaflow types DF8 / DF12 / DF25HDD3 / DF44

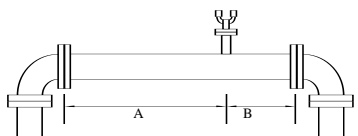
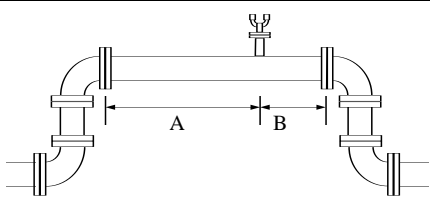
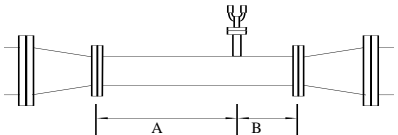
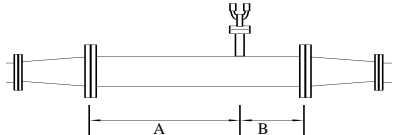
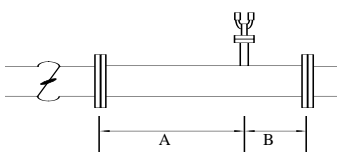
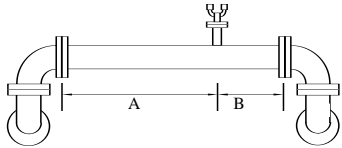
Need further information? Do not hesitate to contact us

If you are not sure which deltaflow is right for your application, feel free to ask! We are happy to assist you.

You can find additional detailed information about the deltaflow in the product pages on our website.

There (Contact & Information) you will also find a listing of sales representatives in your area and our partners

in other countries. There you have also the possibility to send inquiry using our online formular.

Manufacturer Contact

deltaflow is a registered trademark of



systec Controls Mess- und Regeltechnik GmbH

Lindberghstr 4

82178 Puchheim

Germany

Tel: ++49-(0)89-80 90 60 / Fax: ++49-(0)89-80 90 6-200

[Info@systec-controls.de](mailto:info@systec-controls.de)

<http://www.systec-controls.de>

systec Controls GmbH

Lindberghstrasse 4, 82178 Puchheim

Telefon 089 - 80906-0, Telefax 089 - 80906-200

eMail: info@systec-controls.de

<http://www.systec-controls.de>

