

# deltaflow DF44

## Data Sheet



## Overview

### Operational Conditions

- Pressure rating: PN160
- -200 – ca. 550 °C
- DN200 – DN15000 (typical, others on request)
- Media: Gas, Steam, Liquid
- Accuracy: better 1% ,
- Bi-directional, Measurement Range > 1:30
- Certifications: Ex / ATEX / 3.1 / 2.2 / PED97/23/EG
- TÜV design check

### Materials

- 1.4571 (316Ti)
- 1.4539 (904L), Hastelloy C4, Haynes Alloy (mounting material)
- Others on request

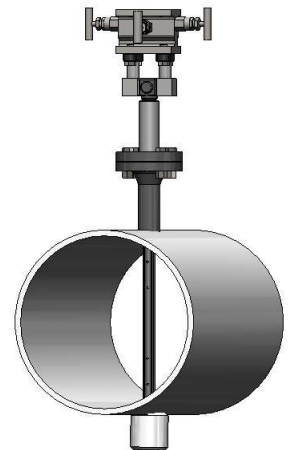

**Figure 1** deltaflow with flange connection, mounted 3-way-manifold and opposite support



**Figure 3 :** deltaflow with cut ring stud, 3-way-manifold, integrated PT100 and multi variable transmitter



**Figure 3:** deltaflow for steam with integrated PT100, 3-way-manifold, mounted transmitter and connection box for cables

### Accessories

- Differential Pressure Transmitter, Multi Variable Transmitter
- Integrated temperature and/or integrated (static) pressure transmitter
- Weather Protection Box with heater for rough conditions
- Air Purging System LSP (see data sheet LSP) for polluted media (dust load up to 200g/m3)
- Flow Computer flowcom e.g. for measurement of heat transfer

## deltaflow Mounting Positions (see also attachment for further information)

### Liquid Service

In order to consider proper venting or draining location depends on type of media and orientation of pipe. To meter liquids, the entire probe should be filled with liquid allowing gas bubbles to vent off. To allow this to happen, the unit should be installed with a slight downward slope from the dp-transmitter towards the measurement profile

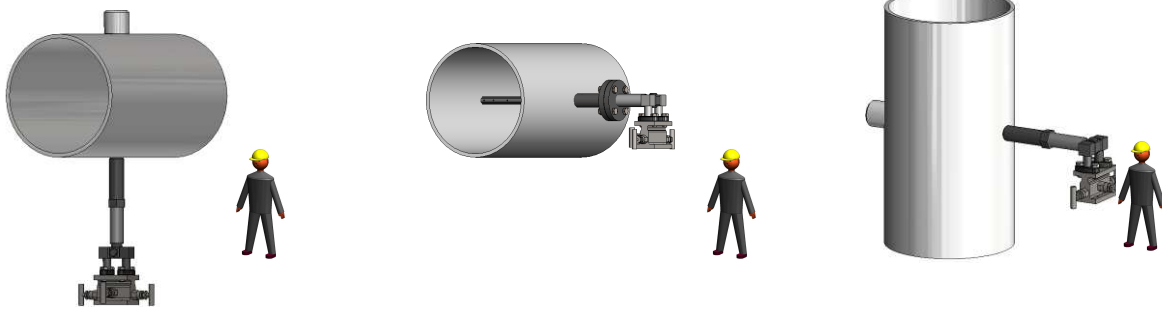

### Gas Service

For gasses, the installation theory is exactly opposite to that of liquids. The deltaflow should be completely filled with the gas, and condensation should be able to drain freely back into the conduit.



### Steam Service

The deltaflow for steam is always installed into the conduit in a horizontal position. The steam condenses in the connection adapters. The differential pressure is then transmitted across the condensate column to the transducer which is located below it.

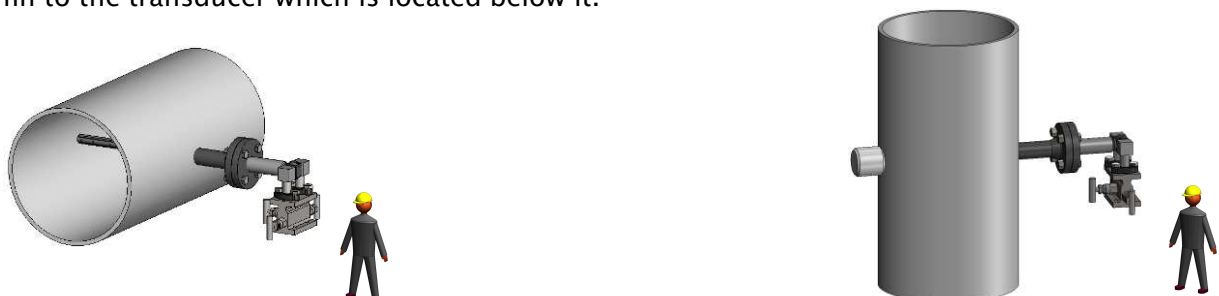

**Figure 4** Overview Mounting Possibilities

### Type Code

	Fluid	Process connection	Nominal Diam	exact inside diameter	exact wall thickness	dp connection	additional dp-connection	material weld-in parts	material probe	pipe insulation	nominal Pressure	pipe orientation	integ Temp	integ Press	options	Customized Options	Bezeichnung
<b>DF44</b>	-	-	<b>DN --</b>	<b>ID - mm</b>	<b>WD - mm</b>	-		-	-	-	-	-	-	-	-		<b>deltaflow Staudrucksonde</b>
	FG																Gas
	FL																Liquid
	FD																Steam
		CF															weld-in-stud with DIN-flange
		CA															weld-in-stud with ANSI-flange
			DN300														nominal diameter max DN300
			DN400														nominal diameter max DN 400
			DN ...														additional length each 100mm
				ID_mm													inside diameter (exact) mm
					WD_mm												wall thickness (exact) mm
						AAN											Welding ends SS ((21.3x3.2mm)
						AN2											Thread, 1/2"NPT male
						AOA											Ovalflanges for direct transmitter mount SS acc. to. DIN EN 61518
						ADW											Oval flanges and three way manifold for direct transmitter mount T 61518
						AKR											Ball valve 1/2" female SS
						AAE											Needle valve welding ends 21.3x2.3mm (1.4571)
						AEN											Needle valve 1/2" NPT female (1.4571)
						AKO											oval flanges on ball valve for direct transmitter mount, SS, acc. To 61518
						XX											other
							AER										Ermeto fitting
							ASW										Swagelock fitting
							MC										CS
							ME										V4A 1.4571 SS316ti
							MV										VA 1.4539
							M										Hastelloy C4
							W										
							MF										16 Mo 3
								SE									V4A 1.4571 SS316ti
									X100								0..100mm
									X---								additional insulation thickness each 25mm
										PN16							PN 16
										PN40							PN 40
										PN100							PN 100
										PN160							PN 160
										AN150							ANSI 150lbs
										AN300							ANSI 300lbs
										AN400							ANSI 400lbs
										AN600							ANSI 600lbs
										AN900							ANSI 900lbs
										PX							other nominal pressure

RV				pipe vertical
RHO				pipe horizontal, installation from top
RHS				pipe horizontal, installation from side
RHU				pipe horizontal, installation from bottom
T3				PT100, max4 00°C
T4				PT100, 4..20mA=0..100°C
T5				PT100, 4..20mA=0..200°C
T6				PT100, 4..20mA=0..300°C
T7				PT100, 4..20mA=0..400°C
T8				Typ K, 4..20mA=0.>.400°C
T9				PT100 Ex, 4..20mA for all temperature ranges
P01				preparation for pressure measurement with G1/2" stud and nut
P02				preparation for pressure measurement with pressure valve G 1/2"
P03				preparation for pressure, with pressure valve and steam siphon G
P1				absolute pressure transmitter Ex
P2				absolute pressure transmitter
P3				absolute pressure transmitter Ex, shut off valve
P4				absolute pressure transmitter, shut off valve
P5				absolute pressure transmitter, shut off valve, siphon
AK1				connection box
3.1				material certificate EN 10204
2.2				material certificate EN 10204
Z				Customized Options required, please specify

1) DF44 is supplied with opposite support as standard (without opposite support only on request)

Table 1 DF44 Type Code

## Type Code in Detail

### Fluid

Code	Explanation
<b>-FG</b>	Please select option FG (Gas) if your medium is a dry gas and neither the conduit nor the ambient pressure contains any condensation to consider. Specifically, dry air and other dried process gasses fall into this category.
<b>-FL</b>	Option FL (liquid) is the correct choice if your medium is a liquid and if boiling (flashing) is not a consideration in either the conduit or the ambient temperature. This category includes the most common liquids such as water, hydrocarbons, etc. Flashing is not generally an issue except in situations involving high temperatures or liquid gasses.
<b>-FD</b>	If your medium is (water-based) steam, then Option FD is the correct choice. The deltaflow will then come equipped with condensation containers and primary shut-off.

Table 2 Model Code for Fluid

If your medium happens to be multi phase (such as cryogenic gas or wet steam), we will be happy to help you find a workable solution. Please contact us.

If your medium is heavily polluted, we would also be happy to help you with our automatic air purging system LSP (see data sheet LSP). We recommend using LSP whenever particle load exceeds 60mg/m<sup>3</sup>. In most applications *deltaflow operates satisfactorily without cleaning and without maintenance.*

## Process Connection

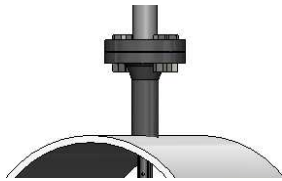
Code	Illustration	Explanation
-CF		Weld-in studs with DIN flanges (option CF) are often used in gauge pressure applications. This model is also well suited to high pressure situations, because the flange uses 4 or more mechanically redundant screws to hold the deltaflow in position. The flange is designed to divert pressure in the event of a leak, thereby preventing media from spurting in the direction of the operator. This means that the flange connection method provides an added measure of safety when the deltaflow is used to meter dangerous media under pressure, such as steam.
-CA		Provides the same advantages as option CF, but uses an ANSI flange instead of a DIN flange.

**Table 3** Model Code process connection

In addition to these standard formats, we can of course adapt the deltaflow to any other installation conditions that might exist. If desired, for example, we could provide you with weld-in studs which could be riveted into a sheet metal channel or cemented into the masonry in a chimney. Previously existing studs can also be used—the nominal diameter must measure at least DN25 (1”), and we would also need a drawing indicating the critical measurements of the existing studs. We are always happy to fulfill special requirements regarding sealing surfaces or materials.

## Nominal Diameter

The deltaflow DF44 can be used within the nominal diameter range of DN200 through DN15000 (typically). For other pipe sizes, please select a different deltaflow model (DF8 / DF12 / DF44).

Code	Explanation
-DN...	Please specify the nominal diameter of your conduit (metric or ANSI units).

**Table 4** Model Code Nominal Diameter

## Inner Diameter

Code	Illustration	Explanation
-ID...		<p>Your deltaflow is custom-built. In order to assure that your deltaflow is ideally suited to your application, we need to know the actual interior diameter and the wall thickness of your conduit. We recommend that this measurement not be taken from your documentation, but rather measured—at the planned sampling site if possible. This is particularly important for applications involving older conduit systems. It is NOT necessary to have this measurement at the bid proposal stage, but it will be required at the time the order is placed.</p>

Table 5 Type Code Inner Diameter

## Wall Thickness



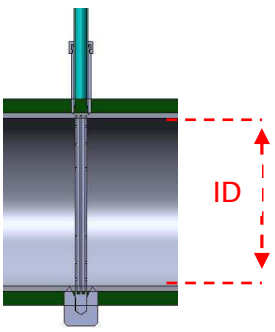

Code	Illustration	Explanation
-WD...		<p>Your deltaflow is custom-built. In order to assure that your deltaflow is ideally suited to your application, we need to know the actual interior diameter and the wall thickness of your conduit. We recommend that this measurement not be taken from your documentation, but rather measured—at the planned sampling site if possible. This is particularly important for applications involving older conduit systems. It is NOT necessary to have this measurement at the bid proposal stage, but it will be required at the time the order is placed.</p>

Table 6 Model Code Wall Thickness

## dp-connection

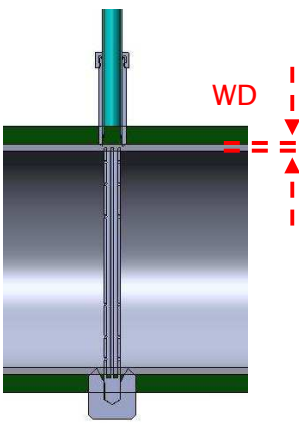
The dp connection you select establishes the way in which you would like to transfer the differential pressure metered at the deltaflow to your dp-transmitter. In addition to the connection formats identified below, other connections can be provided upon request at any time.

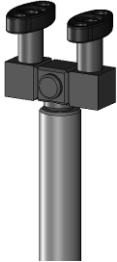
Code	Illustration	Explanation
<b>-AAN</b>		With option AAN you will get your deltaflow with welding ends. Here you have to take care about the connection to your transmitter (impulse piping). Can be used for all kind of media.
<b>-AN2</b>		If you enter option AN2, your deltaflow will come equipped with 1/2" NPT external thread connections. Here you have to take care about the connection to your transmitter (impulse piping). Can be used for all kind of media.
<b>-AOA</b>		If you select option AOA, your deltaflow will be equipped with a flange connection acc. to DIN 19213. Advantage: this feature will allow you to flange most differential pressure transducers directly to the unit without any additional signal conduit. This can save a great deal of time and money. Appropriate for use with all media.
<b>-ADW</b>		In addition to the flange connection (option AOA), the option ADW also comes equipped with a three-way manifold mounted on top of the unit. The three-way manifold makes it possible to install and uninstall the dp-transmitter during operation. It also enables you to perform a zero-point alignment without interrupting your process. As internal piping of the manifold is not capillary free (smaller diameter than 6mm) it is not recommend for humid gases (e.g. biogas)







-AKR		<p>If you select option AKR, you will receive high grade steel ball valves with R 1/2" internal threads. This is generally used with Humid gasses (no capillary effect) when the dp transmitter is to be installed seperately from the probe. Ball valves can be used up to 70bar (35°C) / 200°C (2 bar).</p>
-AAE		<p>If you order option AAE, your probe will come equipped with a stainless steel needle valve. As a standard it will come with welding ends. Alternatively (please specify) it could also have G 1/2", NPT-F 1/2" or Ermeto or Swagelok fittings. Option AAE is generally used for fluids (i.e. feedwater or condensate) and in applications where higher pressures are involved where the dp-transmitter is to be installed in a remote position.</p>
-AEN		<p>Similar to Option AAE (also shut-off valves) but with threaded output (1/2" NPT female)</p>
-AKO		<p>Option AKO (oval flanges on ball valves) is used primarily for humid gasses (i.e. flue gas after scrubber, biogas etc). If you order your deltaflow with this option, you will be able to mount your dp transducer directly onto the oval flanges, and you will also have a completely capillary-free probe. In other words, any condensation which forms can flow unobstructed back into the conduit. This is significant for achieving high levels of precision. Ball valves can be used up to 70bar (35°C) / 200°C (2 bar).</p>
-XX		<p>Customized Solution. Please use this option if you need special connection and specifiy what exactly you need. If you need this option pls. confer with systec- Controls.</p>

Table 7 Model Code DF44 - dp-connections

### Additional dp-connection

In addition to the choosen dp-connection you can select Ermeto or Swagelok fittings. These fittings are typically used for remote mounting (dp-transmitter mounted at remote place) in order to connect deltaflow with dp-transmitter. You can have these fittings along with options AAN, AKR, AAE. We recommend to use AER when using deltaflow DF44 along with air purging system LSP since LSP has also Ermeto inputs (e.g. picture 2)

Code	Illustration	Explanation
-AER		Ermeto fitting 10m
-A		Similar to Option AER but with Swagelok fitting

### Mounting Material (material weld-in parts)

Unless you intend to use an existing connection stud, your deltaflow will be delivered with all studs required for installation (see also *process connection*). You must select the material for these studs that is appropriate to your application (normally chosen material should be similar to pipe material)

Code	Explanation
-MC	Material: Carbon steel (St35.8 or similar) A standard delivery includes weldable studs made of carbon steel. St35.8 material can be welded to almost all common carbon steel pipe systems with no problems. Appropriate for use in normal to high temperature ranges (up to 450° C) and under normal to medium pressures. Non-corrosive—or relatively non-corrosive— media (air, steam, water).
-ME	Weld-in studs can be manufactured of high-grade steel SS316Ti (1.4571) for use under more corrosive conditions. This is usually necessary if the conduits are also constructed of high grade steel. Appropriate for use in normal to high temperatures (up to 550°C) and under normal to high pressures (up to PN400). Corrosive media (salt water, gasses containing HCl).
-MV	Material: High-grade steel 904L (1.4539) Weld-in studs can be manufactured of 1.4539 for use under highly corrosive conditions. Appropriate for use in normal to high temperatures (550° C) and under normal to high pressures. Highly corrosive media (gasses containing HCl or SO <sub>2</sub> , flue gasses prior to wash process).
-MW	Material: Hastelloy C4 Weld-in studs can be manufactured of Hastelloy C4 for use under the very most corrosive conditions. Appropriate for use in normal to high temperatures (1000° C) and under normal to high pressures (PN400). Extremely corrosive media (hot, concentrated acids, highly aggressive and condensing flue gasses prior to wash process).

-MF	Material: 16Mo3 (1.7380, A182-F22) This is the material used to manufacture boilers. Used primarily in steam and feedwater applications at extreme temperatures and pressures.
-----	--

**Table 8** Model Code DF44 – Material of mounting material (weld-in parts)

Other materials may also be available; do not hesitate to ask. Please be prepared to tell us what materials are used in your existing pipe system, and we will then research to determine if the appropriate installation material is available and whether it is suitable for welding.

### Material of Profile / Probe

deltaflow’s patented profile plays a significant role in the flowmeter’s accuracy. Because the profile is surrounded by flowing medium, the mechanical and chemical demands placed on the equipment are especially great. For this reason, the deltaflow is always constructed of premium high-grade steel (1.4571, V4A, 316Ti). If other materials are required please do not hesitate to ask.

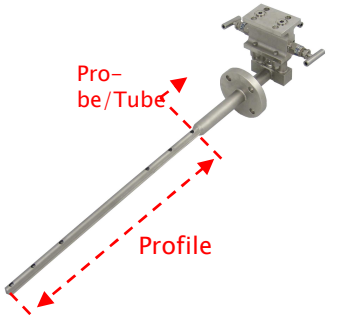
Code	Illustration	Explanation
-SE		Flow profile made of high-grade steel (1.4571, V4A, SS316Ti). Standard material, appropriate to most applications and media (gas, steam, and liquids). Resistant to medium levels of corrosion, and to temperatures up to approximately 550° C. Not appropriate for use in applications where smoke and exhaust contain sulfur particulates (risk of pitting corrosion).

**Table 9** Model Code DF44 – Materials for Profile and Probe

## Pipe Insulation

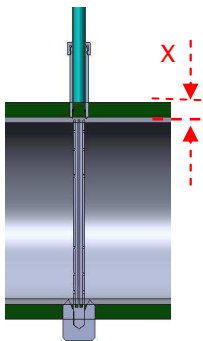
Code	Illustration	Explanation
-X...		<p>The standard height of the DF25 weld-in stud is 125 mm. This length allows the stud to extend up to 100 mm beyond the insulation, sufficient to allow the probe to be installed without removing any of the insulation. If the thickness of your insulation is any greater, systec will customize the height of your stud as required.</p>

**Table 10** Model Code DF44 - Pipe Insulation



## Nominal Pressure

Code	Explanation
-PN... (-AN....)	<p>In order to insure that pressure-bearing parts of the deltaflow meet your requirements, please specify the pressure level within your pipe conduits (use PN for DIN pipes; use lbs. for ANSI pipes). The standard pressure level of the deltaflow DF44 is PN16 and it is available up to PN160.</p>

**Table 11** Model Code DF44 - Nominal Pressure Rating

## Pipe Orientation

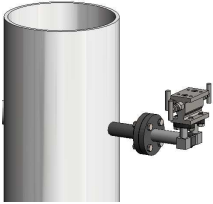
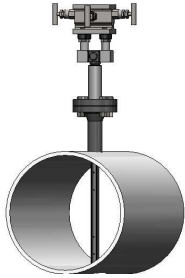
The connections on the deltaflow are designed to accommodate your specific pipe orientation. For liquid service installation should allow remaining air (in internal piping) to vent off. For gas service installation should allow remaining water (e.g. condensate) to drain back into pipe.

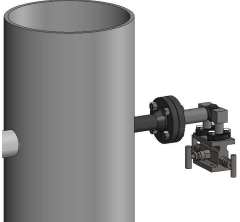
Code	Illustration	Explanation
<p><b>-RV</b></p> <p>Medium Gas (FG) or humid Gas (FF)</p>		<p>To meter gas in vertical conduits, the deltaflow is always installed in a horizontal position with a slight slant (<math>0..3^\circ</math>) toward the point of the probe (tip of deltaflow is at lower position as flange side). The dp connections are designed at an upward-facing angle. This allows any resulting condensation to easily drain back into the conduit.</p>
<p><b>-RHO</b></p> <p>Medium Gas (FG) or humid gas (FF)</p>		<p>For horizontal conduits, we recommend that you install your deltaflow into the pipe from above (12 o'clock position) when you meter gases. Any condensation which develops can drain back to pipe.</p>
<p><b>-RHS</b></p> <p>Medium Gas (FG) or humid gas (FF)</p>		<p>It is also possible to install the deltaflow for gas in a horizontal position (3 o'clock position) in horizontal conduits. An incline of <math>0..3^\circ</math> should be maintained (tip of deltaflow at lower position than flange side) to allow condensation to drain. Connections are installed at right angles facing upwards.</p>
<p><b>-RV</b></p> <p>Medium Liquid (FL)</p>		<p>In vertical conduits, the deltaflow is always installed in a horizontal position with a slight upward slant (<math>0..3^\circ</math>) (tip of deltaflow at higher position than flange side) The dp connections are designed at an angle, facing downwards. This allows gas bubbles to vent-off.</p>

<p><b>-RHU</b></p> <p>Medium Liquid (FL)</p>		<p>For horizontal conduits, we recommend that you install your deltaflow for liquids into the conduit from below (6 o'clock position). This ensures that air can vent-off.</p>
<p><b>-RHS</b></p> <p>Medium Liquid (FL)</p>		<p>It is also possible to install the deltaflow for liquid horizontally (3 o'clock position) in horizontal conduits A slight incline toward the point of the probe should be maintained in order to allow gas to vent-off (tip of deltaflow at higher position than flange side, incline of 0...3°)</p>
<p><b>-RHS</b></p> <p>Medium Steam (FD)</p>		<p>The deltaflow for steam is always installed horizontally with a slight upward slant (0..3°) (tip of deltaflow at a higher position than flange side). The water-filled impulse lines lead downward to the transmitter (transmitter has to be at lower position, there should be a continuous incline between deltaflow and transmitter when using impulse lines)</p>
<p><b>-RV</b></p> <p>Medium Steam (FD)</p>		<p>The deltaflow for steam can be also installed horizontally in vertical conduits, with a slight slant (0..3°) (tip of deltaflow at a higher position than flange side). The water filled impulse lines lead downward to the transmitter (transmitter has to be at lower position, there should be a continuous incline between deltaflow and transmitter when using impulse lines)</p>

Table 12 Model Code DF44 – Pipe Orientation



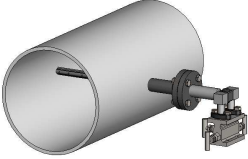
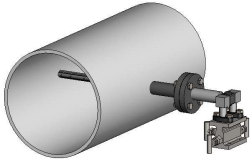
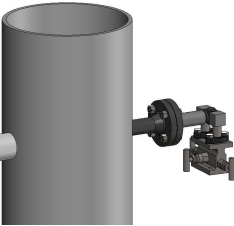
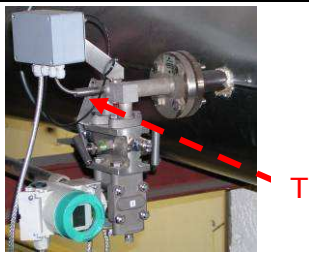

## Integrated Temperature Sensor

There is the possibility to integrate a temperature sensor and/or a sensor for static pressure in your deltaflow. On request there are also external screw-in meters available.

Code	Illustration	Explanation
-T3		Integrated PT100 element max. 400°C. PT100 can be removed under pressurized conditions.
-T4		Integrated PT100 with transmitter for 4...20mA output (4...20mA = 0...100°C) Requires Option AK1 (cable box)
-T5		Integrated PT100 with transmitter for 4...20mA output (4...20mA = 0...200°C) Requires Option AK1 (cable box)
-T6		Integrated PT100 with transmitter for 4...20mA output (4...20mA = 0...300°C) Requires Option AK1 (cable box)
-T7		Integrated PT100 with transmitter for 4...20mA output (4...20mA = 0...400°C) Requires Option AK1 (cable box)
-T8		Integrated thermal element (Type K) with transmitter for 4...20mA output (4...20mA=0...XXX °C). Please specify desired measurement range (XXX) Requires Option AK1 (cable box)
-T9		Integrated PT100 with transmitter for 4...20mA output (4...20mA = 0...XXX °C) for ATEX zones (all temperature ranges). Requires Option AK1 (cable box). Please specify desired measurement range (XXX)

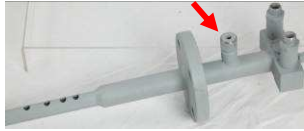
**Table 13** Model Code DF44 - Integrated meter for temperature

## Integrated Pressure Transmitter (for static pressure)

Code	Illustration	Explanation
-P01		preparation for pressure transmitter with G1/2" stud (for use with separate transmitter)
-P02		preparation for pressure transmitter with G1/2" stud and needle valve G 1/2" (for use with separate transmitter)
-P03		Preparation for pressure transmitter, with pressure valve and steam siphon, thread-connection G1/2". Siphon is required for steam applications (for use with separate transmitter)
-P1		absolute pressure transmitter for use in ATEX areas. Output 4...20mA
-P2		absolute pressure transmitter. Output 4...20mA
-P3		absolute pressure transmitter for use in ATEX areas. With needle valve. Output 4...20mA
-P4		absolute pressure transmitter. With needle valve. Output 4...20mA (Same as -P3 but no suited for ATEX area)



-P5		absolute pressure transmitter with needle valve and siphon (required for steam applications). Output 4...20mA
-----	---	---

Table 14 Model Code DF44 - Integrated transmitter for static pressure

### Options

Code	Illustration	Explanation
-AK1		Cable box for wiring when using integrated temperature and/or pressure meter. Material: Aluminium. Including Cable Glands
-3.1		Material Certificate acc. To EN 10204 with batch numbers of all used materials. With that option all materials are fully traceable back to steel mill.
-2.2		Factory Certificate acc. To EN10204. This certificate is issued by systec Controls and confirms that this deltaflow was made of a special (desired) material.

Table 15 Model Code D44 - Options

### Customized Options

Code	Explanation
-Z	If you need any customized options please ask your systec dealer and/or specify at your order.

### Upstream & Downstream Distances with/without use of ImproveIT

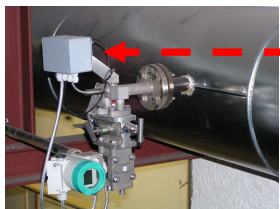
The new ImproveIT database makes it possible to use the deltaflow in applications where the inlet runs are very short (see also deltaflow product brochure for further informations. The following table shows upstream and downstream distances (in multiples of inner pipe diameter DI) and the corresponding accuracies when using ImproveIT. [No improveIT possible in case of valves and pumps possible]

Mounting Situation	Expected Accuracy	Without Improve IT		Using Improve IT	
		Inlet A	Outlet B	Inlet A	Outlet B
	0,5%	14 x DI	3 x DI	7 x DI	3 x DI
	<b>1,0%</b>	<b>7 x DI</b>	<b>3 x DI</b>	4 x ID	3 x ID
	2,0 %	4 x DI	2 x DI	1 x DI	2 x DI
	0,5%	18 x DI	3 X DI	7 x DI	3 x DI
	<b>1,0%</b>	<b>9 x DI</b>	<b>2 x DI</b>	4 x ID	3 x ID
	2,0 %	5 x DI	2 x DI	2 x DI	1 x DI
	0,5%	14 x DI	3 x DI	7 x DI	3 x DI
	<b>1,0%</b>	<b>7 x DI</b>	<b>3 x DI</b>	4 x D	3 X D
	2,0 %	4 x DI	2 x DI	1 x DI	1 x DI
	0,5%	14 x DI	3 x DI	8 x DI	3 x DI
	<b>1,0%</b>	<b>7 x DI</b>	<b>3 x DI</b>	4 X D	3 X D
	2,0 %	4 x DI	2 x DI	2 x DI	1 x DI
	0,5%	36 x DI	6 x DI		
	<b>1,0%</b>	<b>24 x DI</b>	<b>4 x DI</b>		
	2,0 %	12 x Di	3 x DI		
	0,5%	24 x DI	6 X DI	12 x DI	3 x DI
	<b>1,0%</b>	<b>17 x DI</b>	<b>4 x DI</b>	7 x D	3 x D
	2,0 %	9 x DI	3 x DI	2 x DI	2 X DI

Table 16 Required Upstream & Downstream Distances

## Further Information

At [www.systec-controls.de](http://www.systec-controls.de) -> Products -> deltaflow

- deltaflow product brochure
- deltaflow Installation guide
- deltaflow calculation basics
- deltacalc calculation software for primary elements
- Data sheets of deltaflow types DF8 / DF12 / DF25HDD3 / DF25

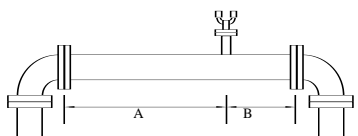
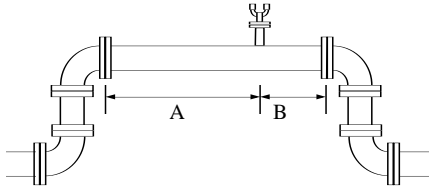
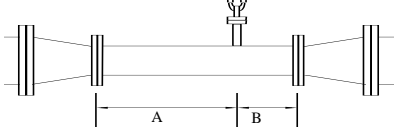
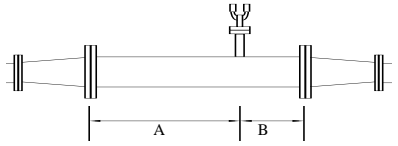
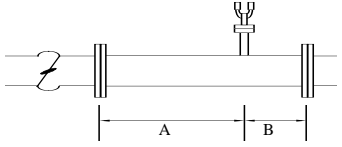
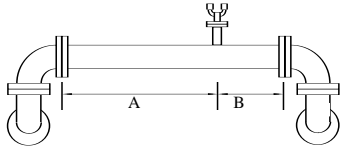
## Need further information? Do not hesitate to contact us

If you are not sure which deltaflow is right for your application, feel free to ask! We are happy to assist you. You can find additional detailed information about the deltaflow in the product pages on our website. There (Contact & Information) you will also find a listing of sales representatives in your area and our partners in other countries. There you have also the possibility to send inquiry using our online formular.

## Manufacturer Contact



deltaflow is a registered trademark of

systec Controls Mess- und Regeltechnik GmbH  
Lindberghstr 4  
82178 Puchheim  
Germany  
Tel: ++49-(0)89-80 90 60 / Fax: ++49-(0)89-80 90 6-200  
[Info@systec-controls.de](mailto:Info@systec-controls.de)  
<http://www.systec-controls.de>

systec Controls GmbH  
Lindberghstrasse 4, 82178 Puchheim  
Telefon +49 89 80 906 0, Telefax +49 89 80 90 6 200  
eMail: [info@systec-controls.de](mailto:info@systec-controls.de)  
<http://www.systec-controls.de>

